

RETTUNGSDATENBLÄTTER

Škoda

Modellbezeichnung

Modellzyklus

F

- Felicia
- Felicia Combi
- Fabia I
- Fabia Sedan I
- Fabia Combi I
- Fabia II
- Fabia Combi II

1994 - 2001
1995 - 2001
1999 - 2007
2001 - 2008
2000 - 2007
ab 2006
ab 2006

O

- Octavia I
- Octavia Combi I
- Octavia II
- Octavia Combi II
- Octavia II LPG
- Octavia Combi II LPG

ab 1996
ab 2000
ab 2004
ab 2004
ab 2009
ab 2009

P

- Pick up

1995 - 2001

R

- Roomster

ab 2006

S

- Superb I
- Superb II
- Superb Combi II

2001 - 2008
ab 2008
ab 2009

Y

- Yeti

ab 2009

?

Schnellfinder am
rechten Seitenrand



Hinweis:

Diese Dokumentation wurde ausschließlich für Rettungskräfte erstellt, die über eine spezielle Ausbildung auf dem Gebiet der technischen Hilfeleistung nach Verkehrsunfällen und damit in Verbindung stehender Tätigkeiten verfügen.

Spezifikationen und Sonderausstattungen der Škoda-Fahrzeuge sowie das Škoda-Fahrzeugangebot unterliegen stetig etwaigen Änderungen. Daher behält sich Škoda Auto a.s. inhaltliche Anpassungen bzw. Änderungen jederzeit ausdrücklich vor.

Beachten Sie bitte, dass die in dieser Dokumentation enthaltenen Informationen nicht für Endkunden und ebenfalls nicht für Werkstätten und Händler bestimmt sind. Endkunden finden detaillierte Informationen zu den Funktionen ihres Fahrzeugs sowie wichtige Sicherheitshinweise zur Fahrzeug- und Insassensicherheit in den Bordbüchern jedes Škoda-Fahrzeugs. Werkstätten und Händler können die nötigen Reparaturinformationen über die ihnen bekannten Bezugsquellen erhalten.

(Stand: Oktober 2009)

Hinweis:

In den Modellübersichten ist immer die maximal mögliche Ausstattung eines Fahrzeugs gezeigt.

Artikelnummer S00 5186 53 00



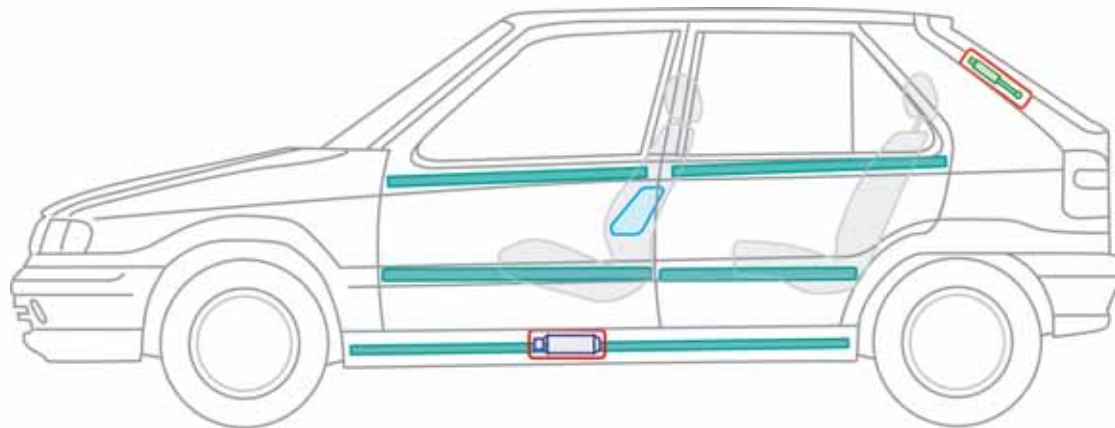
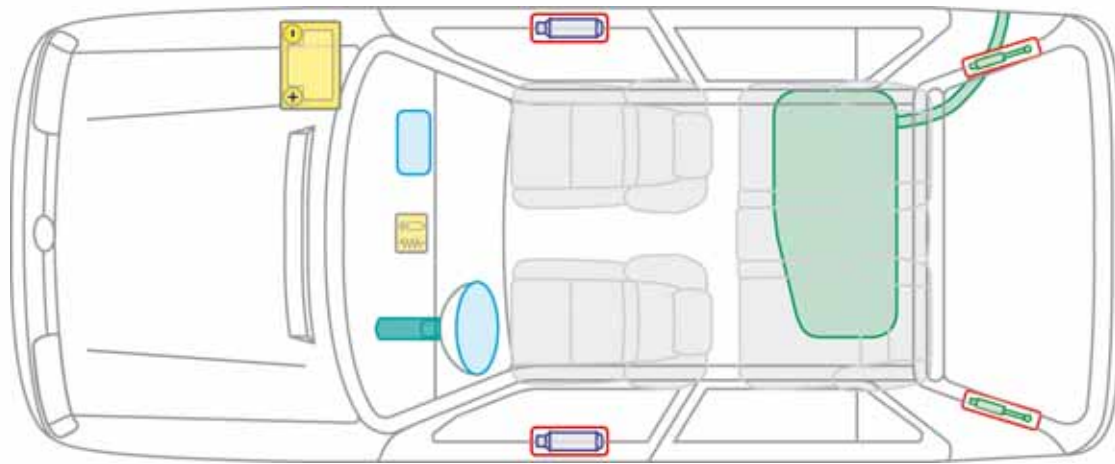

Allgemeine Informationen zur Rettung und Bergung finden Sie im Leitfaden für Rettungsdienste „Retten und Bergen aus verunfallten Fahrzeugen“ mit der Artikelnummer S00 5186 26 00.

Felicia

1994 - 2001

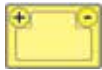

Legende





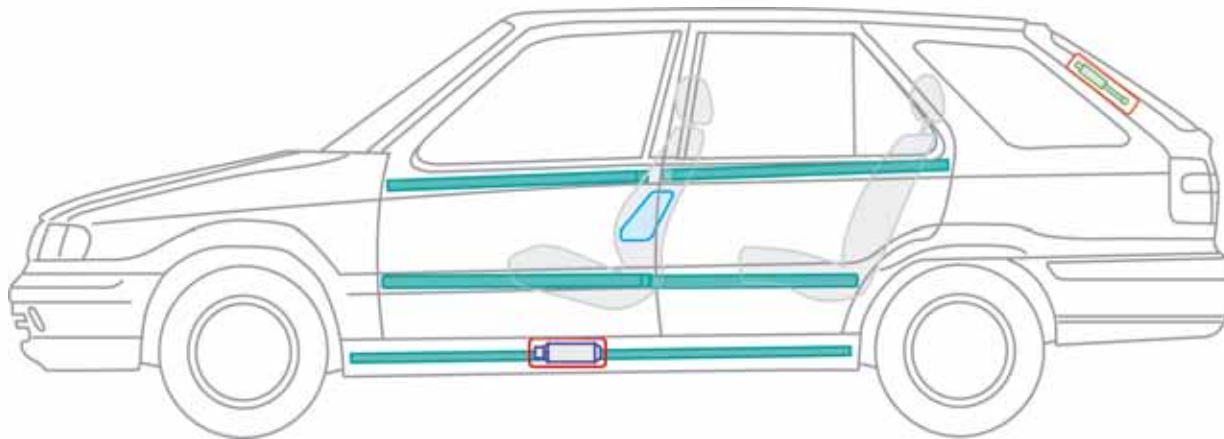
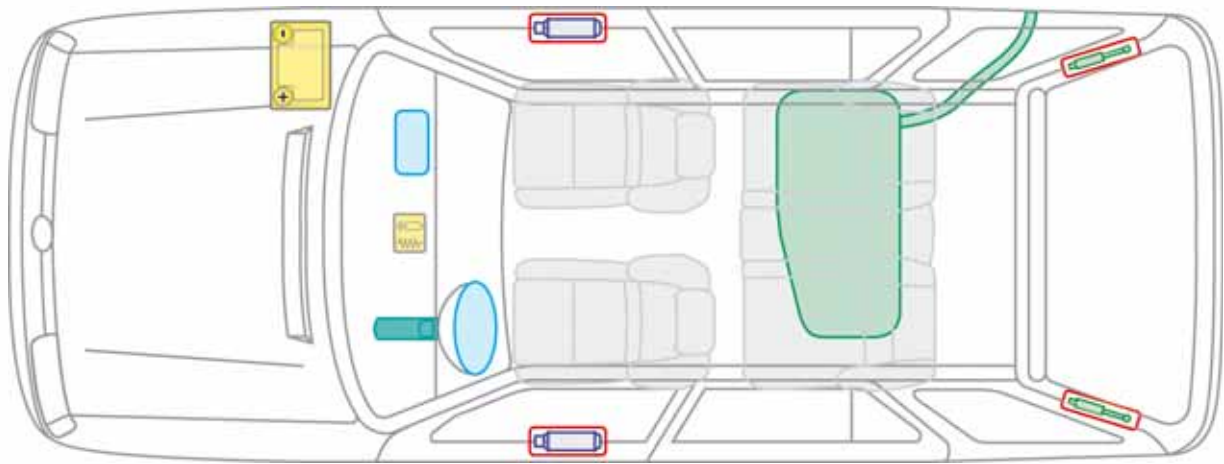

	Airbag		Karosserie- verstärkung		Steuergerät für Airbag
	Gas- generator		Batterie		Gasdruck- dämpfer
	Kraftstoff- tank				

Felicia Combi

1995 - 2001



Legende

	Airbag		Karosserie- verstärkung		Steuergerät für Airbag
	Gas- generator		Batterie		Gasdruck- dämpfer
	Kraftstoff- tank				

F

Felicia Combi



Fabia I

1999 - 2007

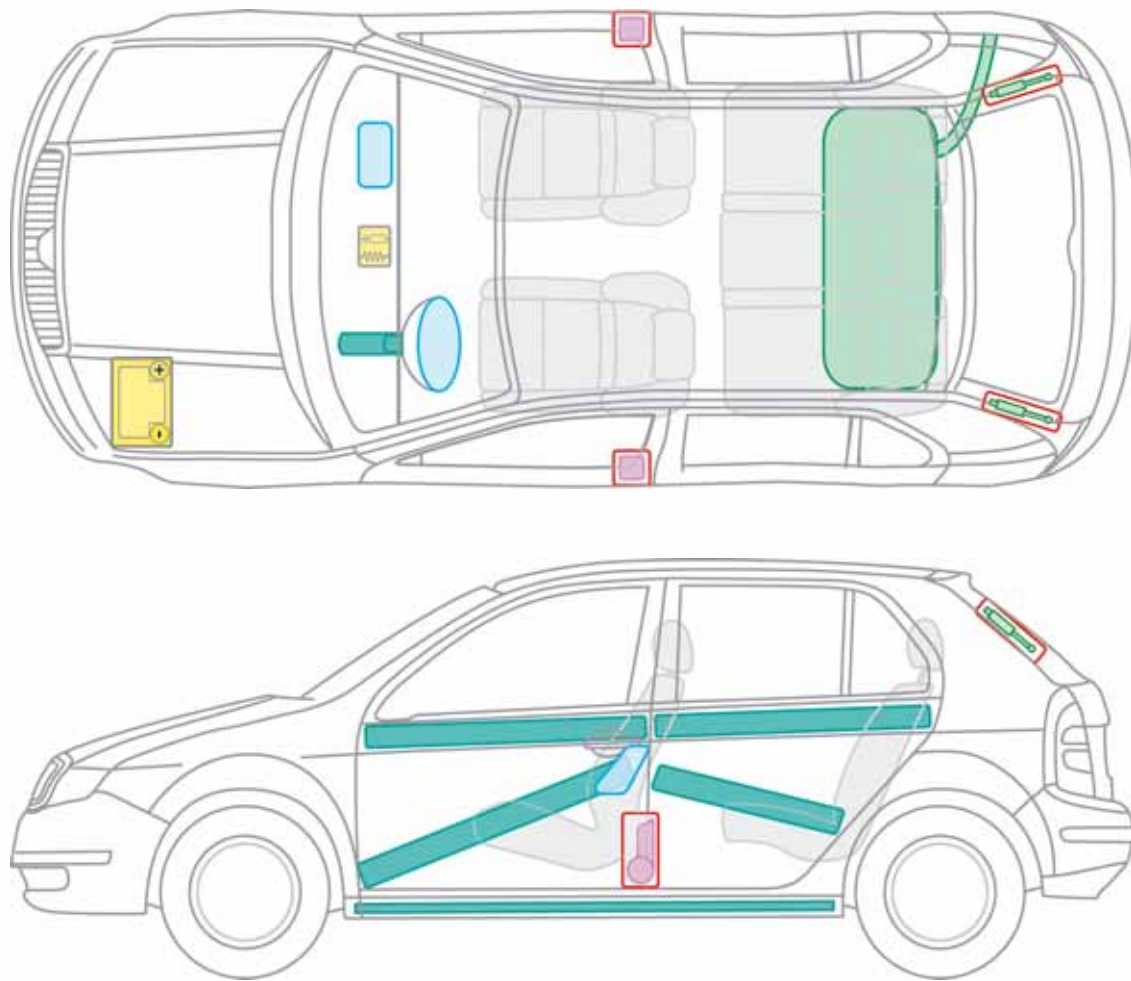

Legende

	Airbag		Karosserie- verstärkung		Steuergerät für Airbag
	Batterie		Gurtstraffer		Gasdruck- dämpfer
	Kraftstoff- tank				

Fabia Sedan I

2001 - 2008

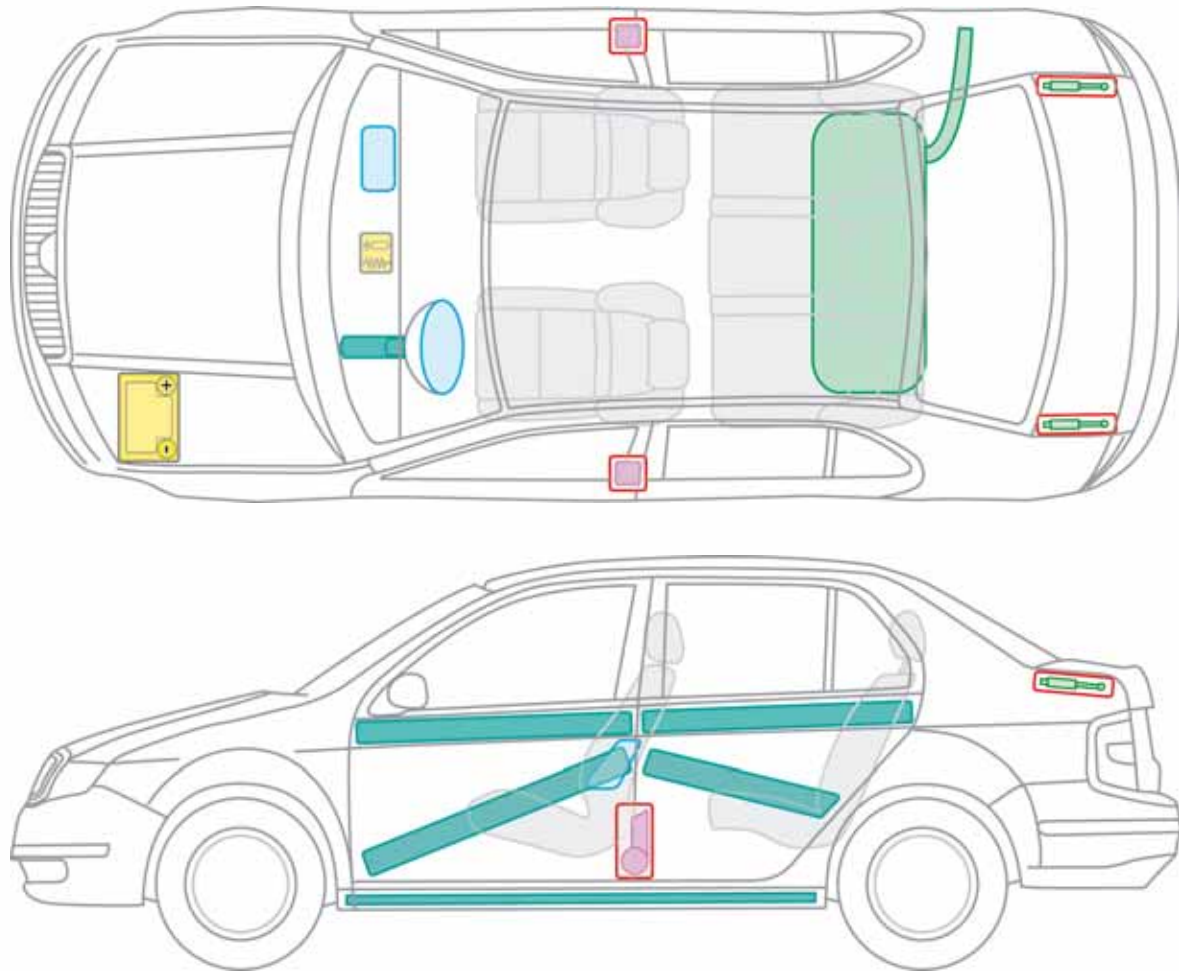

Legende

	Airbag		Karosserie- verstärkung		Steuergerät für Airbag
	Batterie		Gurtstraffer		Gasdruck- dämpfer
	Kraftstoff- tank				

Fabia Combi I

2000 - 2007

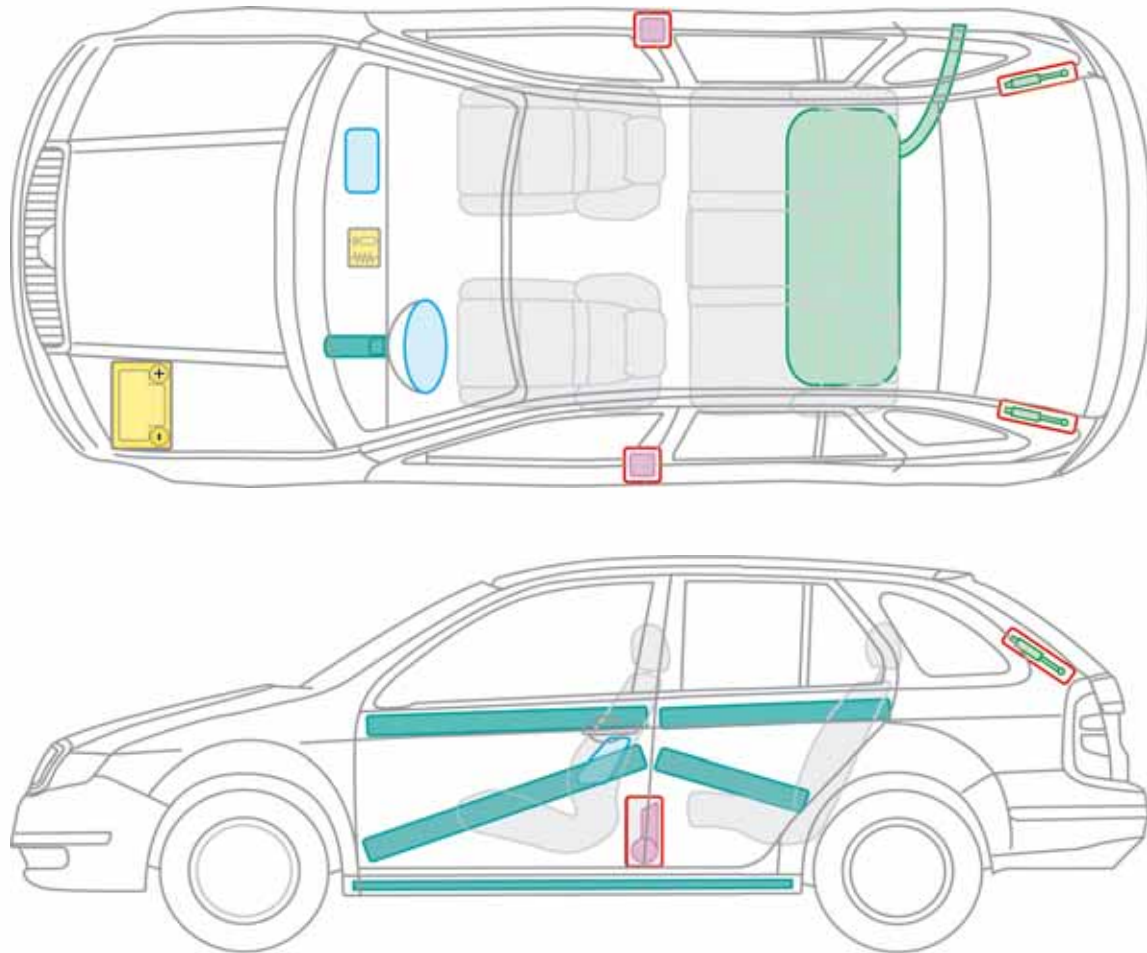

Legende

	Airbag		Karosserie- verstärkung		Steuergerät für Airbag
	Batterie		Gurtstraffer		Gasdruck- dämpfer
	Kraftstoff- tank				

Fabia II ab 2006

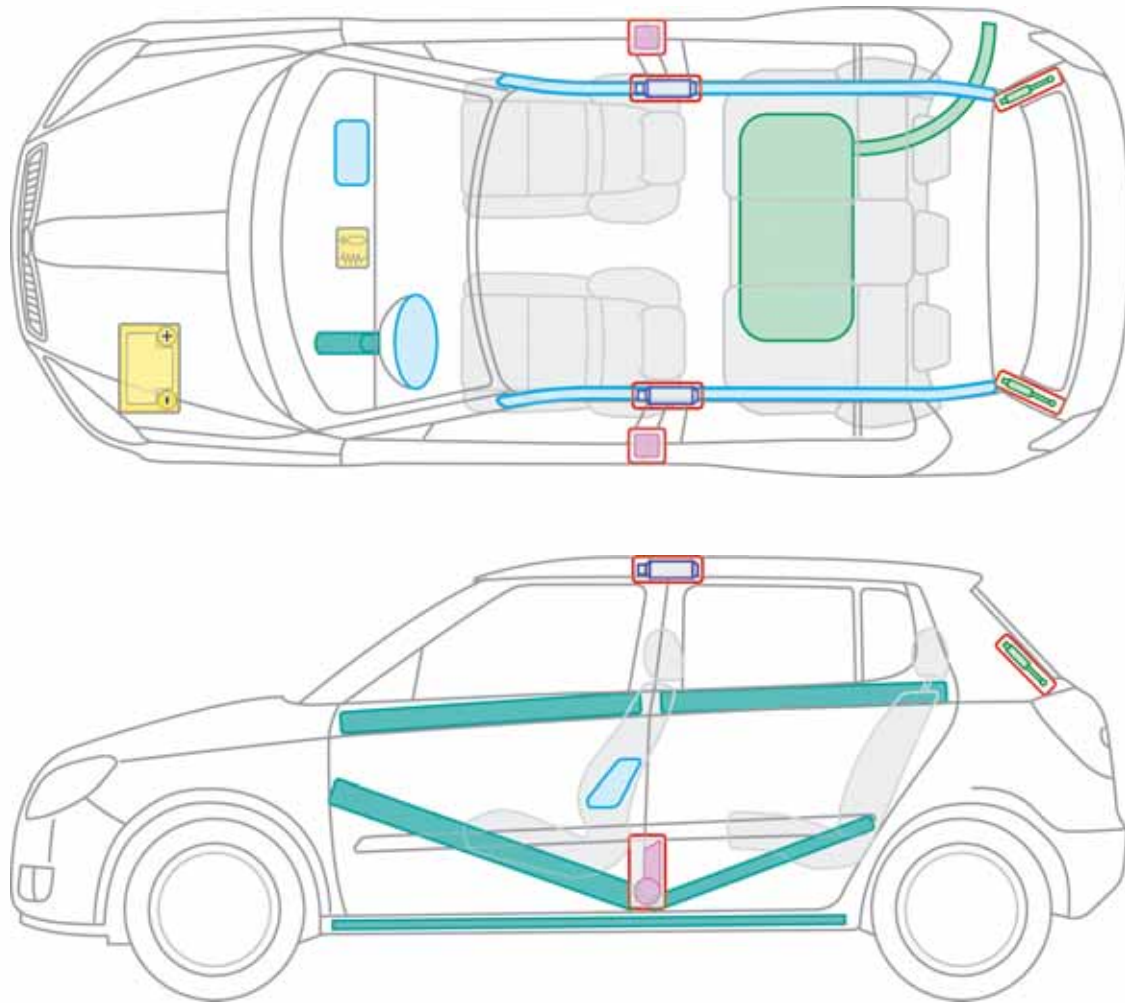

Legende

	Airbag		Karosserie- verstärkung		Steuergerät für Airbag
	Gas- generator		Batterie		Gurtstraffer
	Gasdruck- dämpfer		Kraftstoff- tank		

Fabia Combi II

ab 2006

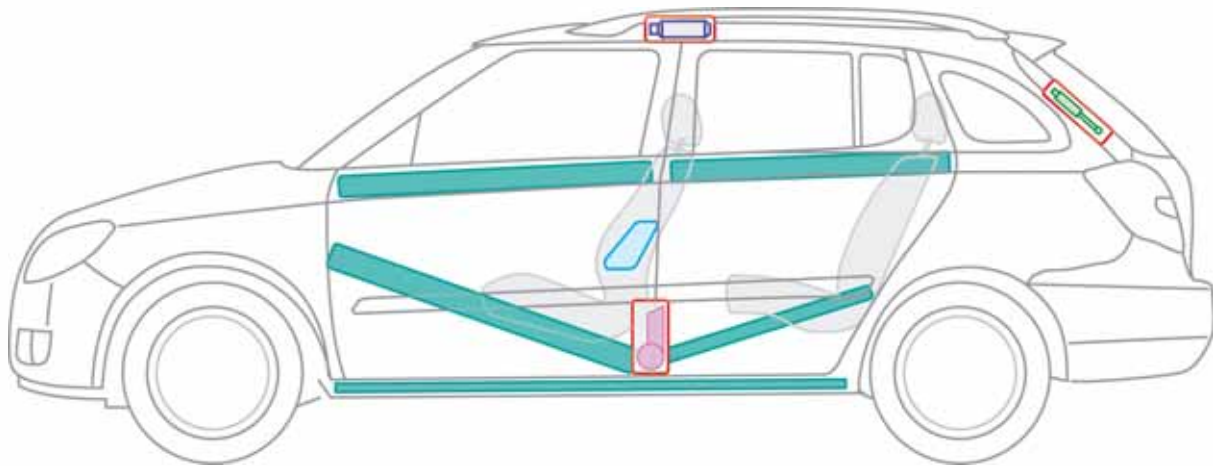
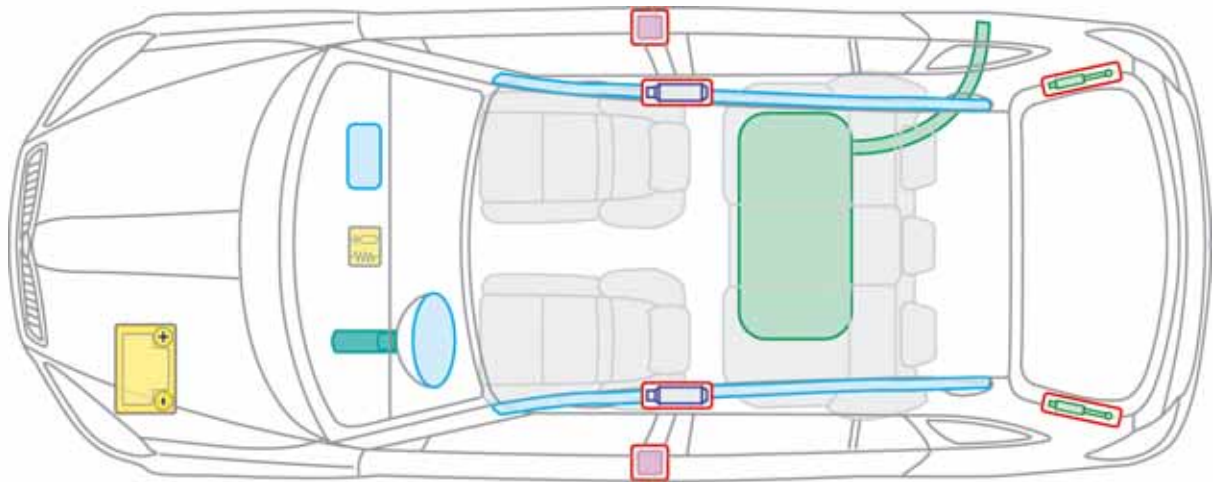

Legende

	Airbag		Karosserie- verstärkung		Steuergerät für Airbag
	Gas- generator		Batterie		Gurtstraffer
	Gasdruck- dämpfer		Kraftstoff- tank		

Octavia I ab 1996

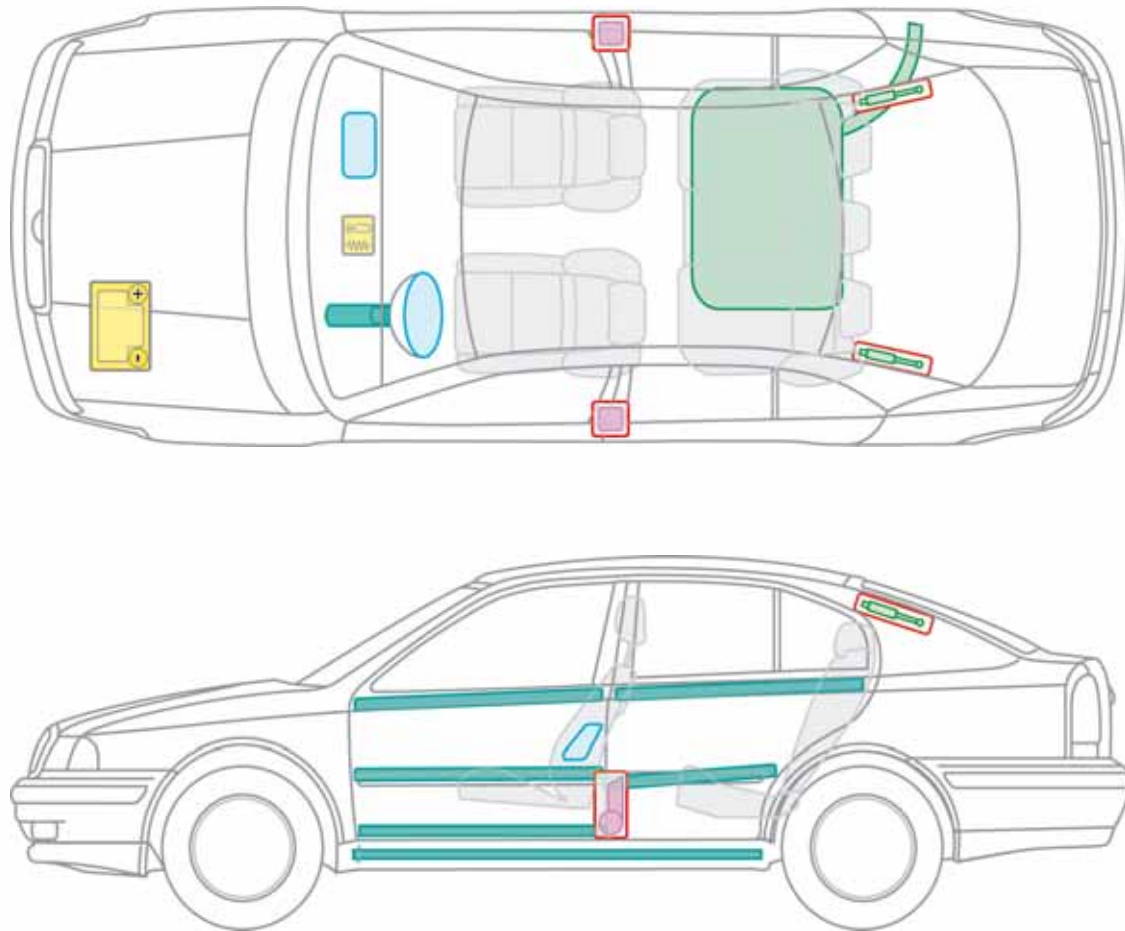

Legende

	Airbag		Karosserie- verstärkung		Steuergerät für Airbag
	Batterie		Gurtstraffer		Gasdruck- dämpfer
	Kraftstoff- tank				

O

Octavia I

Octavia Combi I ab 2000

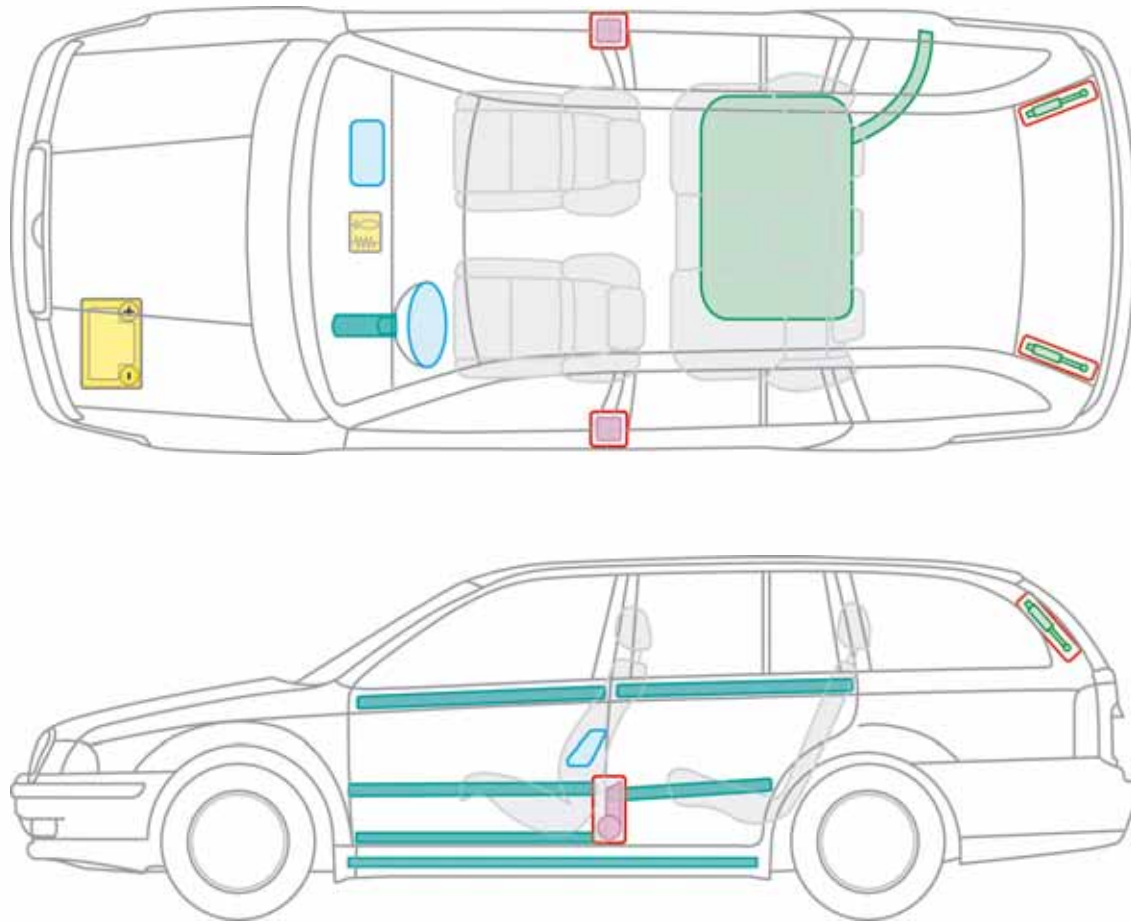

Legende

	Airbag		Karosserie- verstärkung		Steuergerät für Airbag
	Batterie		Gurtstraffer		Gasdruck- dämpfer
	Kraftstoff- tank				

O

Octavia Combi I

Octavia II ab 2004

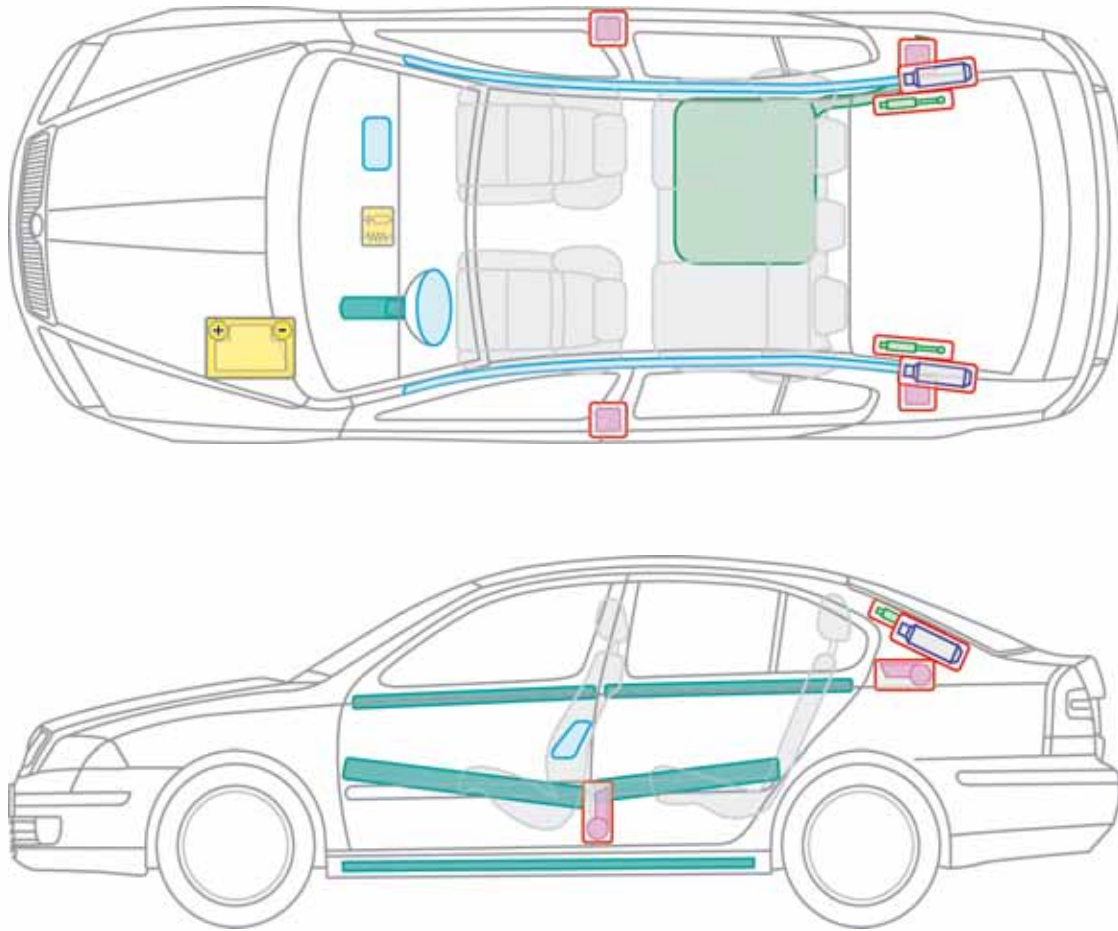

Legende

	Airbag		Karosserie- verstärkung		Steuergerät für Airbag
	Gas- generator		Batterie		Gurtstraffer
	Gasdruck- dämpfer		Kraftstoff- tank		

O

Octavia II



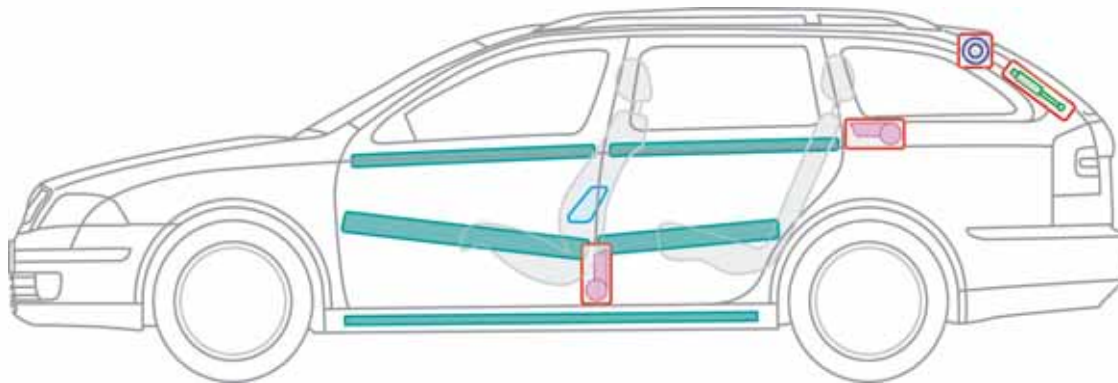
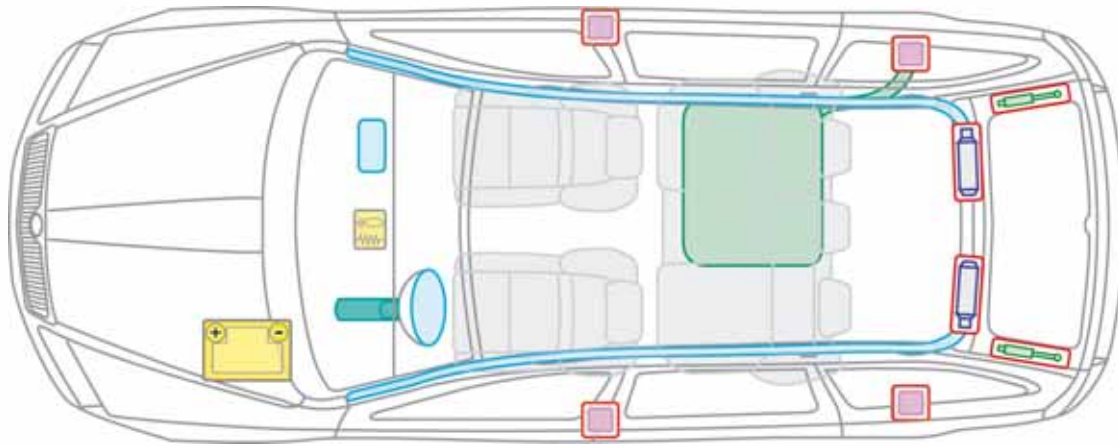

Octavia Combi II

ab 2004



Legende

	Airbag		Karosserie- verstärkung		Steuergerät für Airbag
	Gas- generator		Batterie		Gurtstraffer
	Gasdruck- dämpfer		Kraftstoff- tank		

O

Octavia Combi II



Octavia II LPG

ab 2009

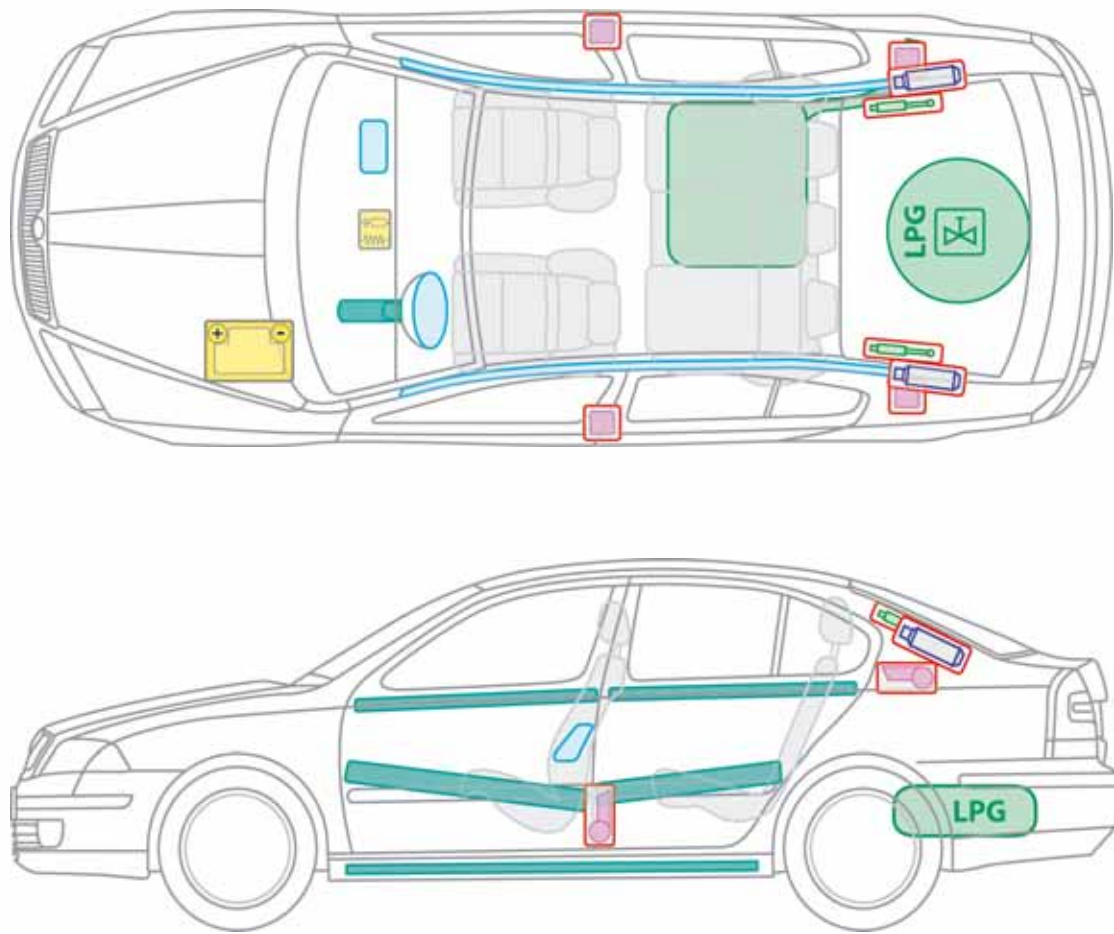

Legende

	Airbag		Karosserie- verstärkung		Steuergerät für Airbag
	Gas- generator		Batterie		Gurtstraffer
	Gasdruck- dämpfer		Kraftstoff- tank		Multifunk- tionsventil

O

Octavia II LPG



Octavia Combi II LPG ab 2009

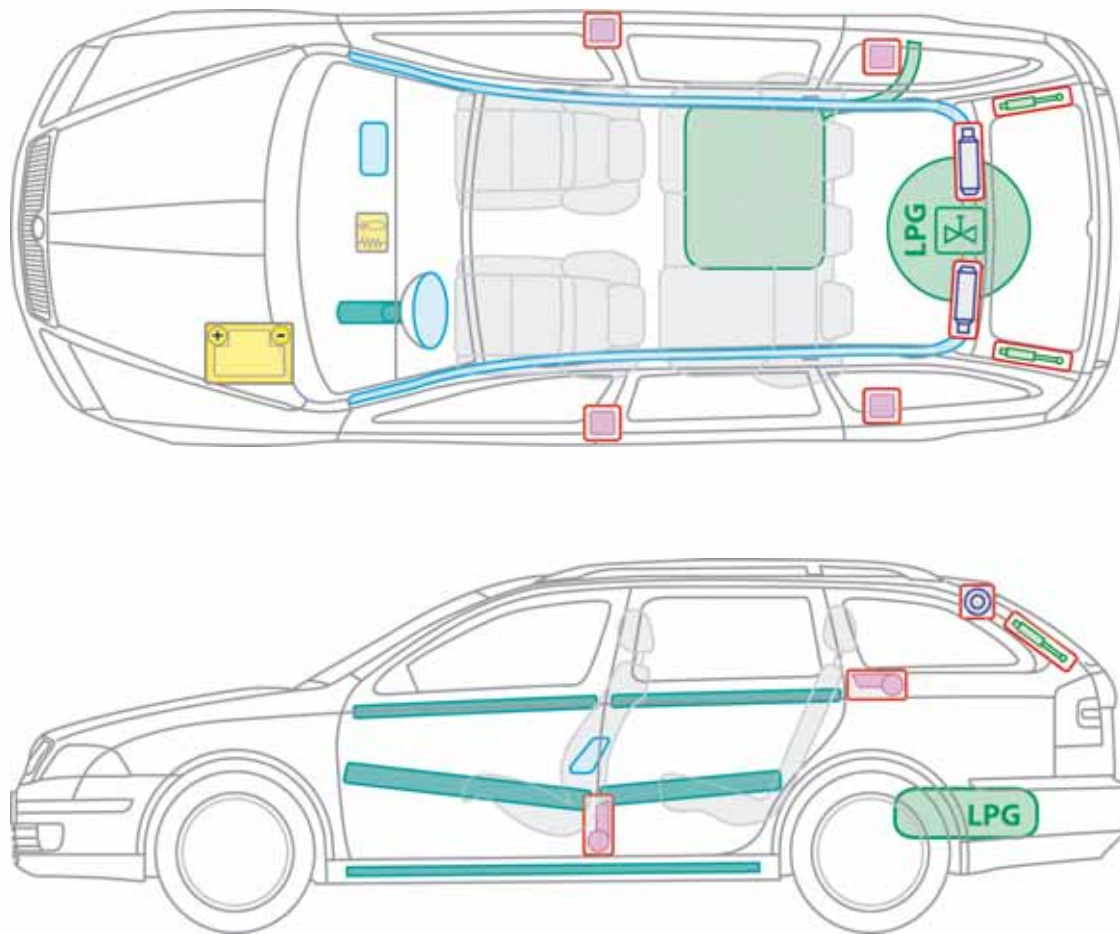



Legende

	Airbag		Karosserie- verstärkung		Steuergerät für Airbag
	Gas- generator		Batterie		Gurtstraffer
	Gasdruck- dämpfer		Kraftstoff- tank		Multifunk- tionsventil

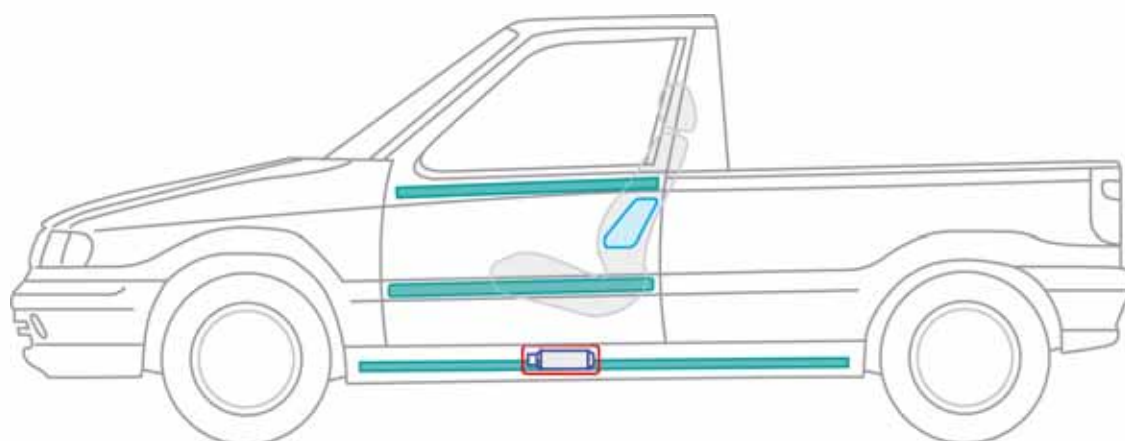
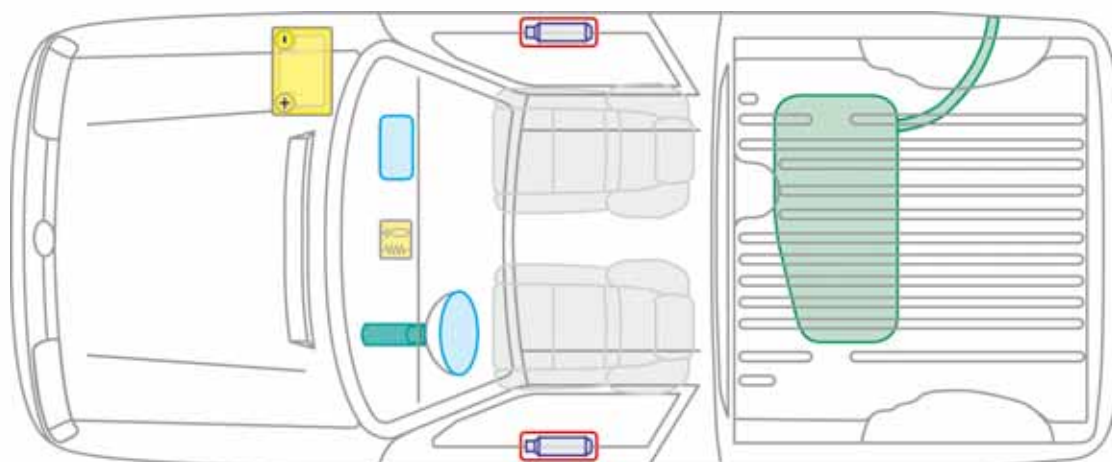
Pick up 1995 - 2001



Legende

	Airbag		Karosserie- verstärkung		Steuergerät für Airbag
	Gas- generator		Batterie		Gasdruck- dämpfer
	Kraftstoff- tank				

P

Pick up

Roomster ab 2006

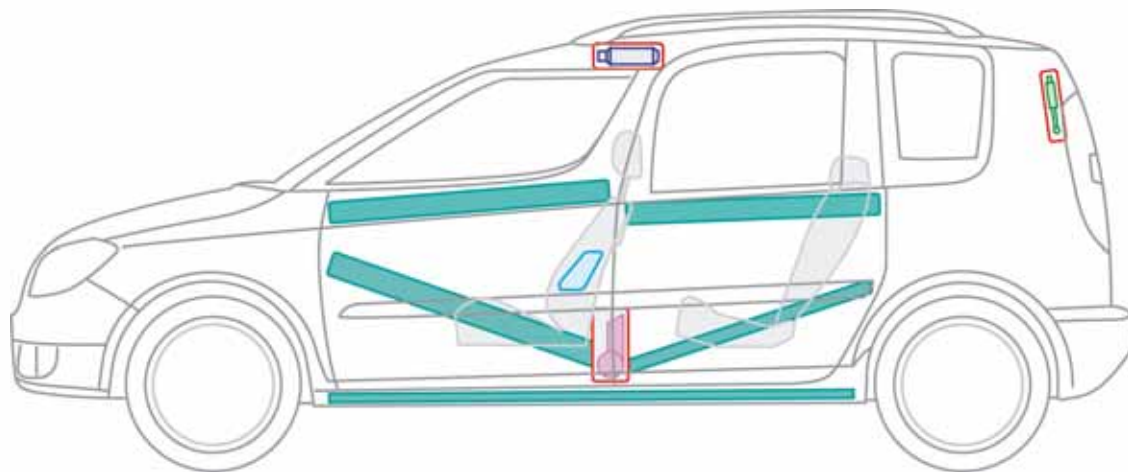
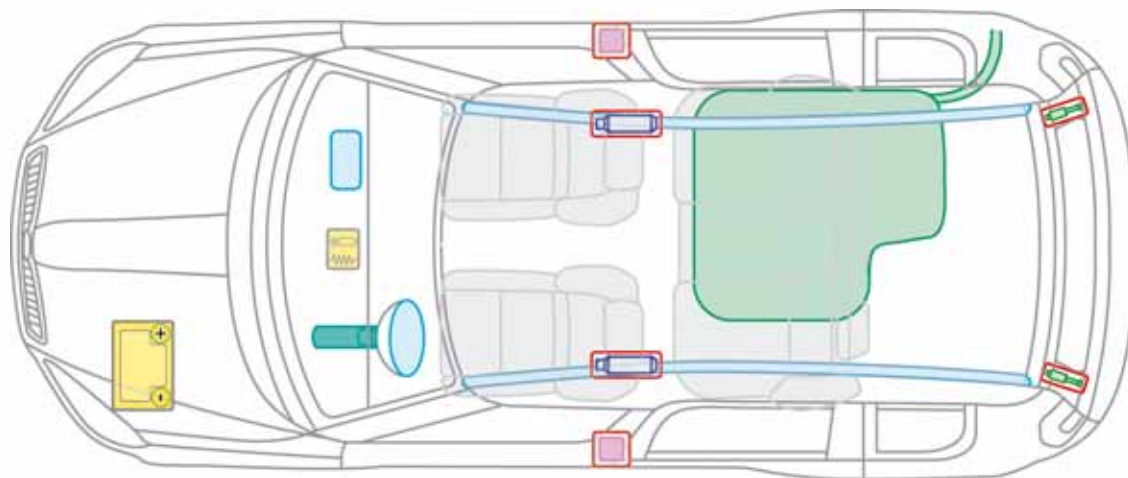

Legende

	Airbag		Karosserie- verstärkung		Steuergerät für Airbag
	Gas- generator		Batterie		Gurtstraffer
	Gasdruck- dämpfer		Kraftstoff- tank		

R

Roomster



Superb I 2001 - 2008

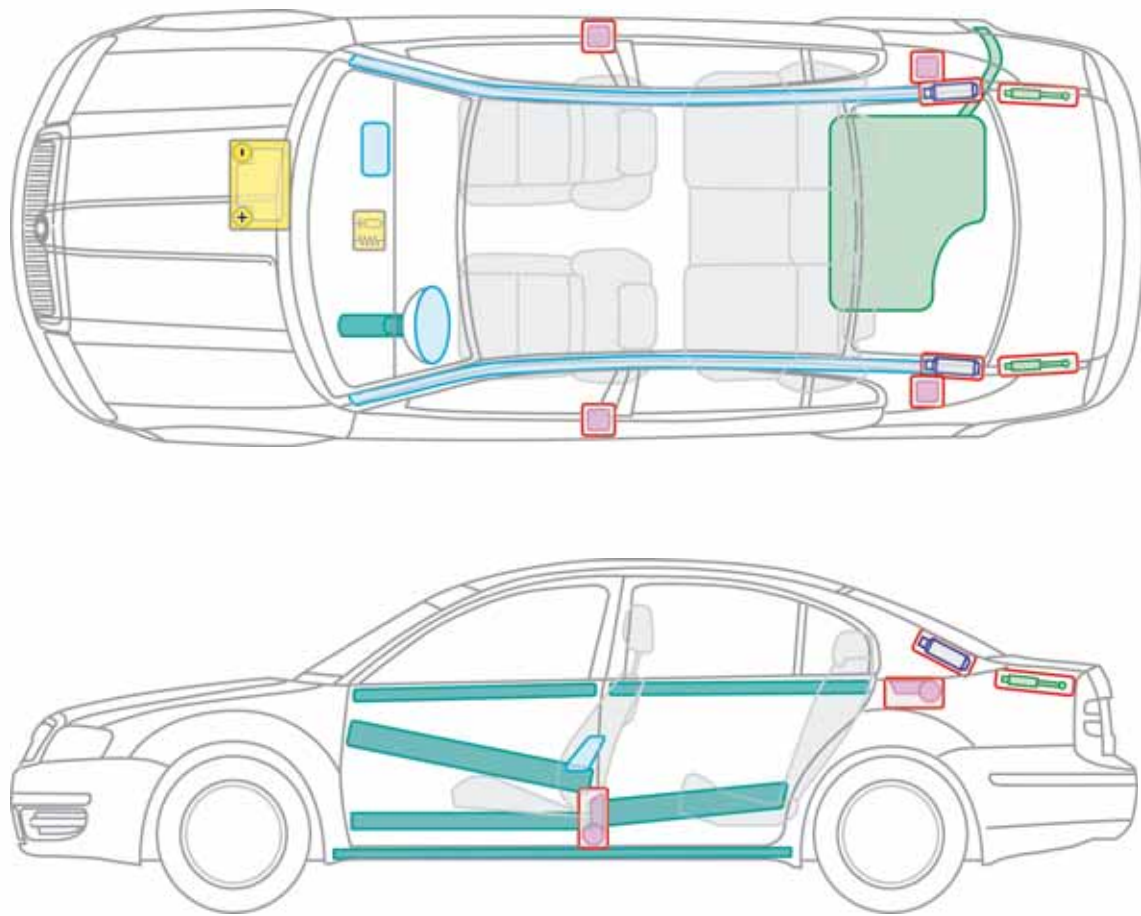

Legende

	Airbag		Karosserie- verstärkung		Steuergerät für Airbag
	Gas- generator		Batterie		Gurtstraffer
	Gasdruck- dämpfer		Kraftstoff- tank		

S

Superb I



Superb II ab 2008

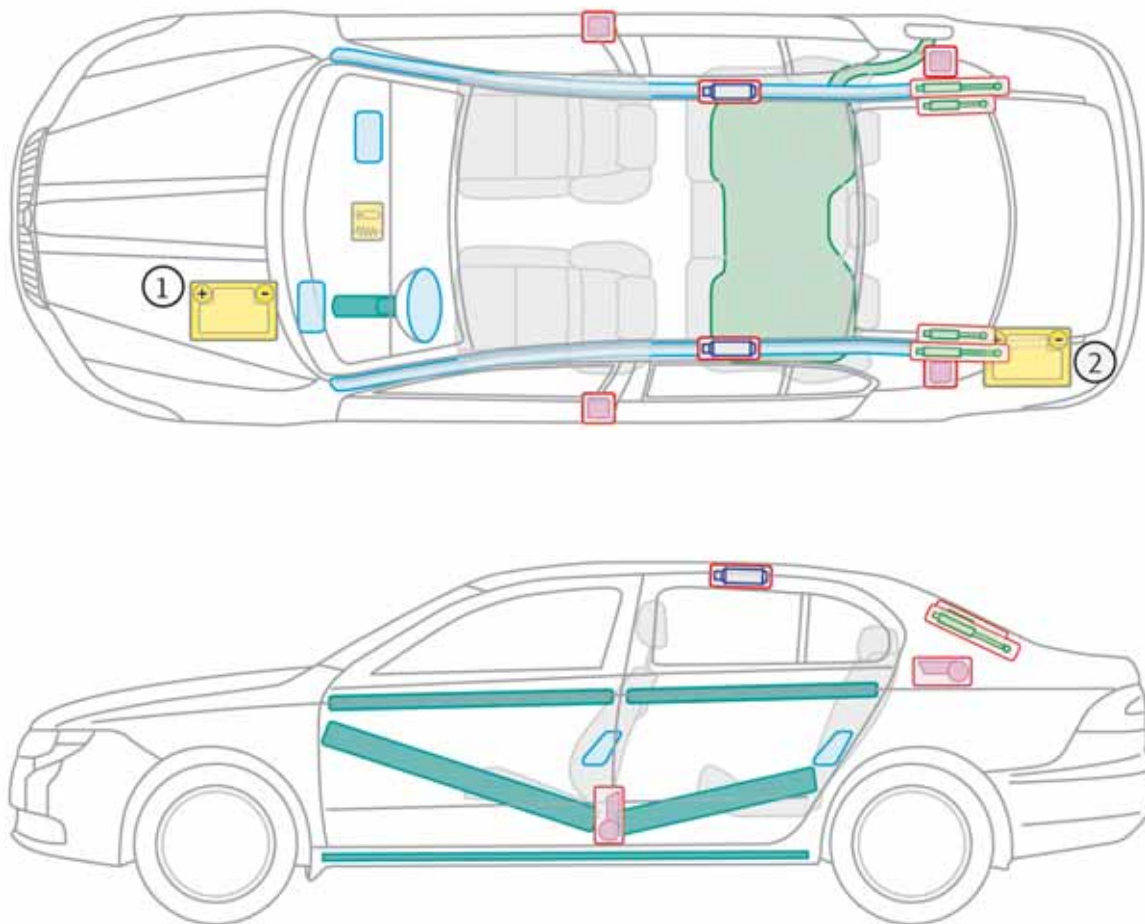

- ① alle Fahrzeuge, außer Motorisierung 3,6 I/191 kW
 ② alle Fahrzeuge, mit Motorisierung 3,6 I/191 kW

Legende

	Airbag		Karosserie- verstärkung		Steuergerät für Airbag
	Gas- generator		Batterie		Gurtstraffer
	Gasdruck- dämpfer		Kraftstoff- tank		

S

Superb II



Superb Combi II

ab 2009

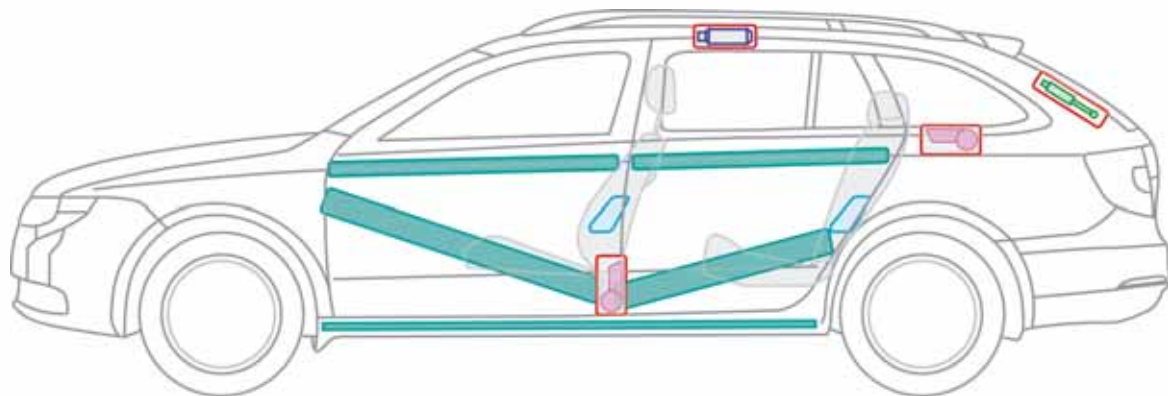
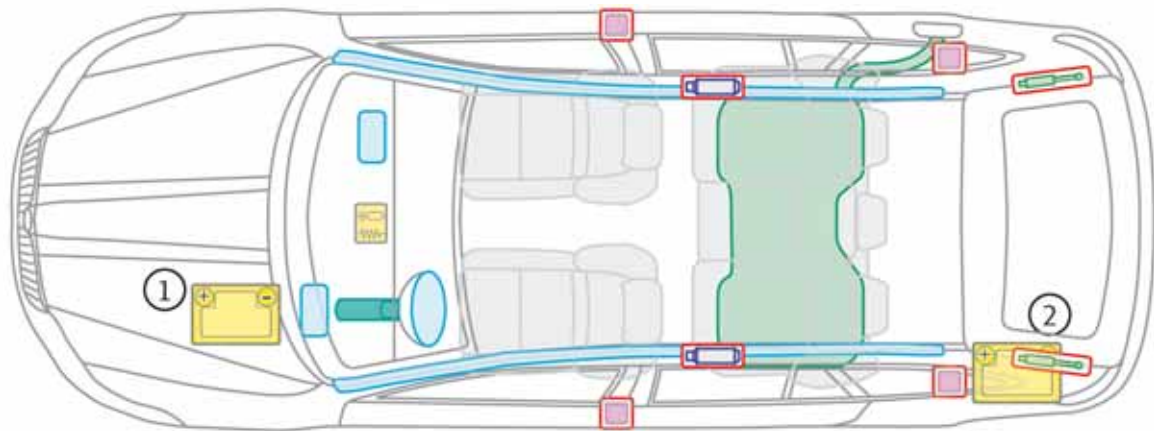

- ① alle Fahrzeuge, außer Motorisierung 3,6 I/191 kW
 ② alle Fahrzeuge, mit Motorisierung 3,6 I/191 kW

Legende

	Airbag		Karosserie- verstärkung		Steuergerät für Airbag
	Gas- generator		Batterie		Gurtstraffer
	Gasdruck- dämpfer		Kraftstoff- tank		

S

Superb Combi II



Yeti
ab 2009

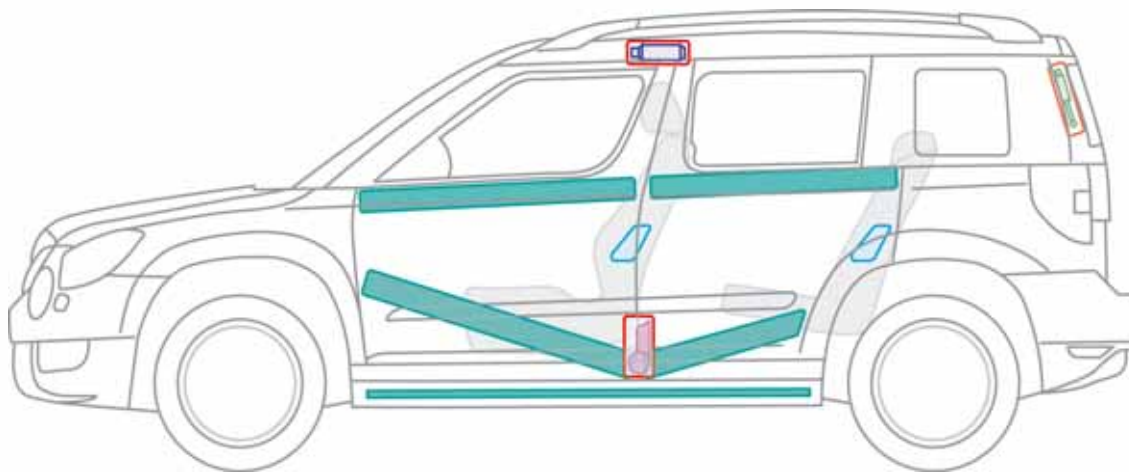
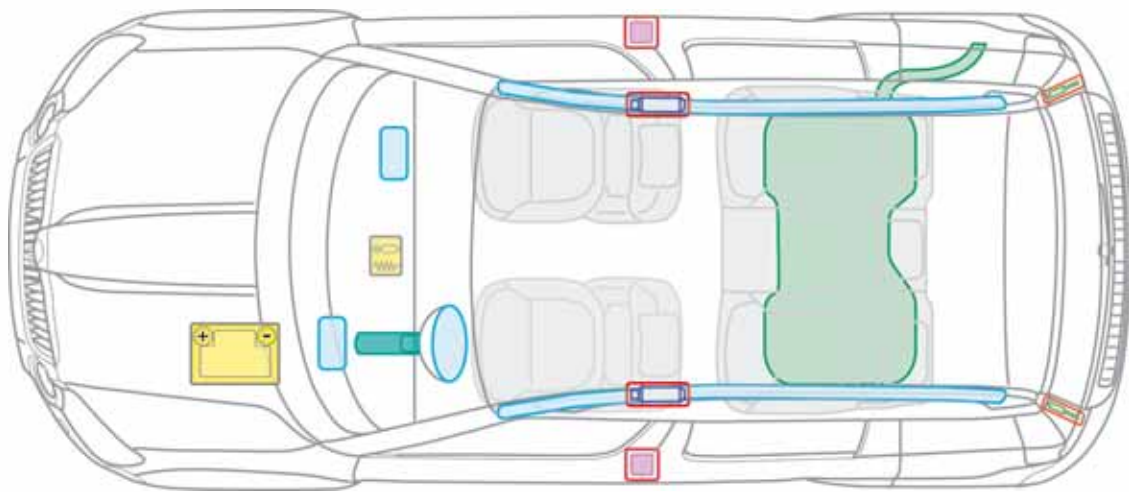

Legende

	Airbag		Karosserie- verstärkung		Steuergerät für Airbag
	Gas- generator		Batterie		Gurtstraffer
	Gasdruck- dämpfer		Kraftstoff- tank		

Y

Yeti

